



# AVS Solutions Day 2024

Challenges for audioconferencing in larger hybrid workspaces  
and how to resolve them

Nureva Audio Conferencing

# Microphone Mist™ Technology

The virtual mic difference

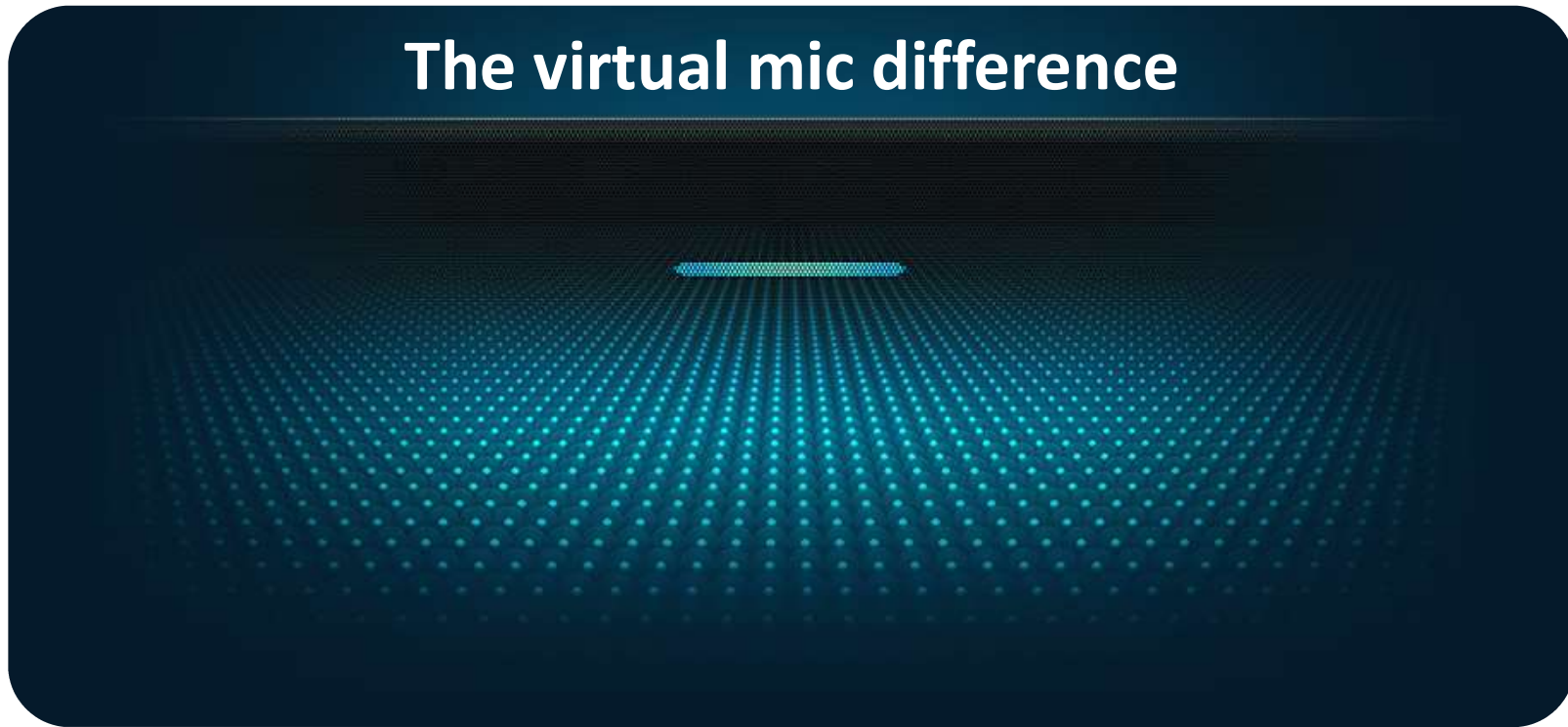

# Nureva solution family

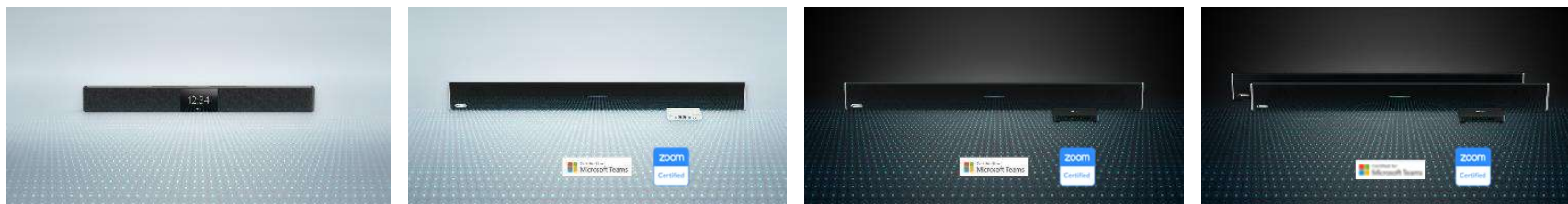

Small & medium-sized rooms	Large rooms		Extra-large rooms
<b>HDL200</b>	<b>HDL300</b>	<b>HDL310</b>	<b>HDL410</b>
For rooms up to 5.5 x 5.5 m	For rooms up to 7.6 x 7.6 m	For rooms up to 9.1 x 9.1 m	For rooms up to 10.7 x 16.8 m



Gen 1 Connect Module



Gen 2 Connect Module



Gen 2 Connect Module

# Larger Spaces for hybrid collaboration

Extra-large boardroom



Large Microsoft Signature Room



Large training room

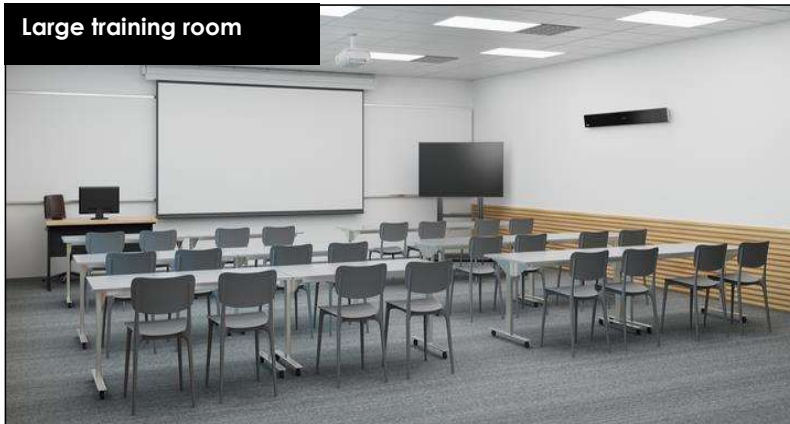

Divisible rooms





# Challenges

# Challenges for Audio Conferencing

- I. Complexity
- II. Flexible Spaces
- III. Divisible Rooms
- IV. Full room Audio Pick up and Full Room Video

# I. Complexity



- QSC Q-SYS Core 110f processor
- QSC SPA4-100 power amplifier
- (2) QS AD-S802T column loudspeakers
- (2) QSC AD-P6t pendant loudspeakers
- QSC NS1108P network switch
- (2) Sennheiser TeamConnect Ceiling 2 microphone
- (2) Sennheiser SL CM SK suspension kit
- 7' Cat 6 Ethernet cable
- (2) 35' Cat 5e plenum Ethernet cable
- (2) 50' Cat 5e plenum Ethernet cable
- USB 2.0 A male to B male cable
- 150' 16 AWG 2-conductor plenum speaker cable

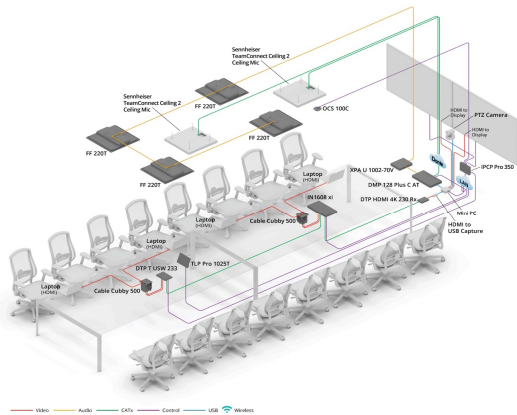

Source: <https://www.microsoft.com/en-ca/microsoft-teams/across-devices/devices/product/qsc-extra-large-room-directional-audio-with-ceiling-speakers/708>



- Nureva HDL410 audio conferencing system
  - (2) integrated microphone and speaker bars
  - (2) 50' CAT 6 ethernet cable
  - USB Type A-B cable
  - Connect Module
  - Remote control

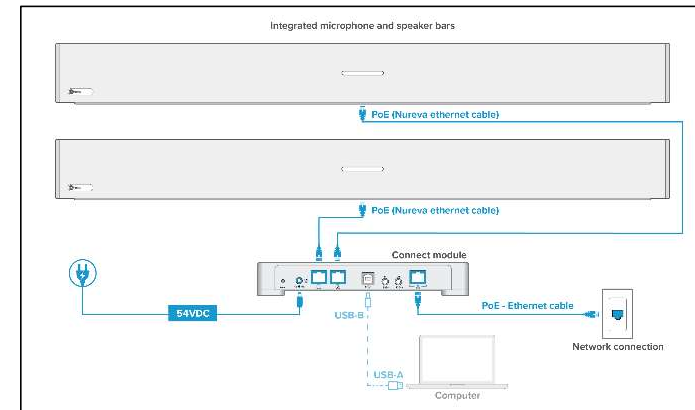

Source: <https://www.microsoft.com/en-ca/microsoft-teams/across-devices/devices/product/nureva-hdl410-b-audio-conferencing-system/31338>



## II. Flexible Spaces



- Continuous autocalibration
- Full room pick-up



## II. Flexible Spaces



- Mobile installation

# III. Divisible Rooms

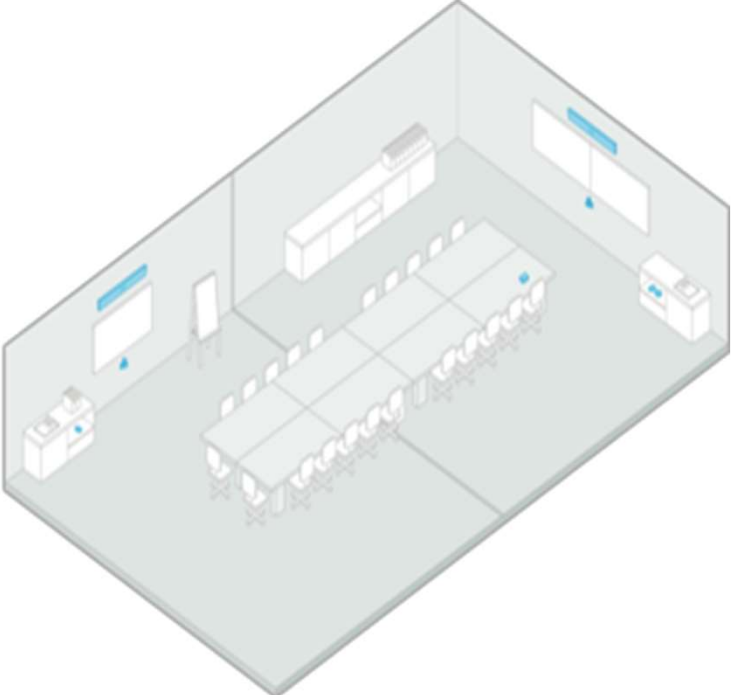
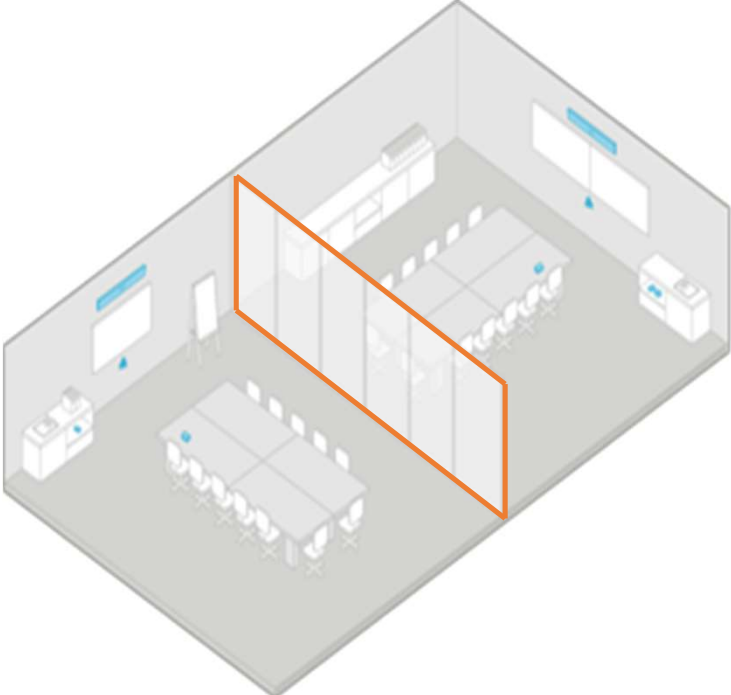

# III. Divisible Rooms

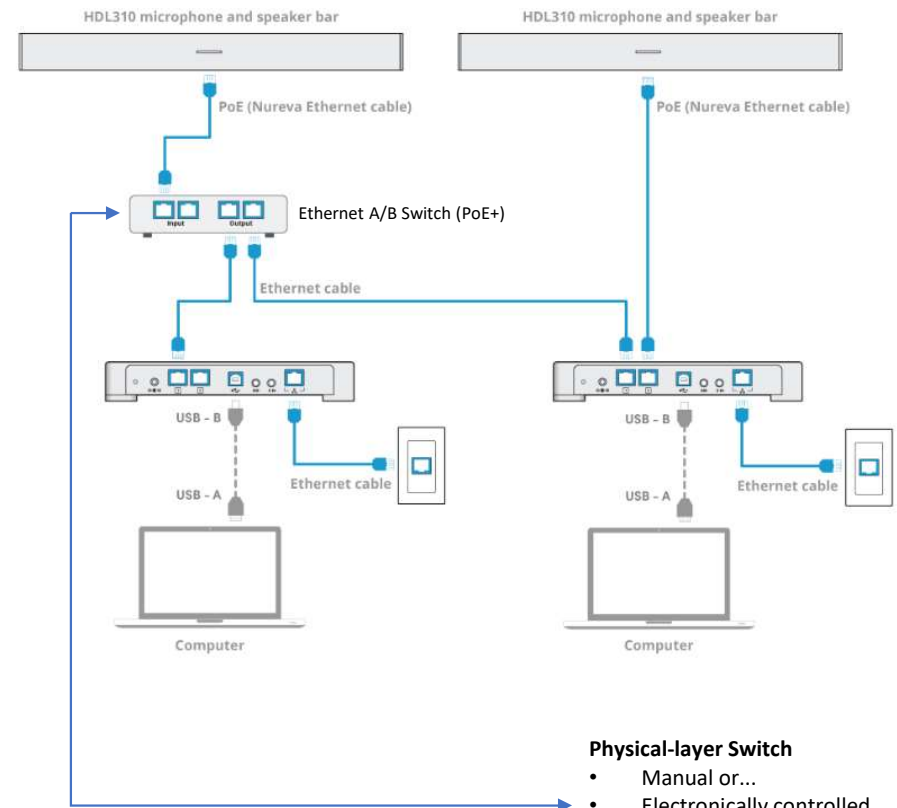
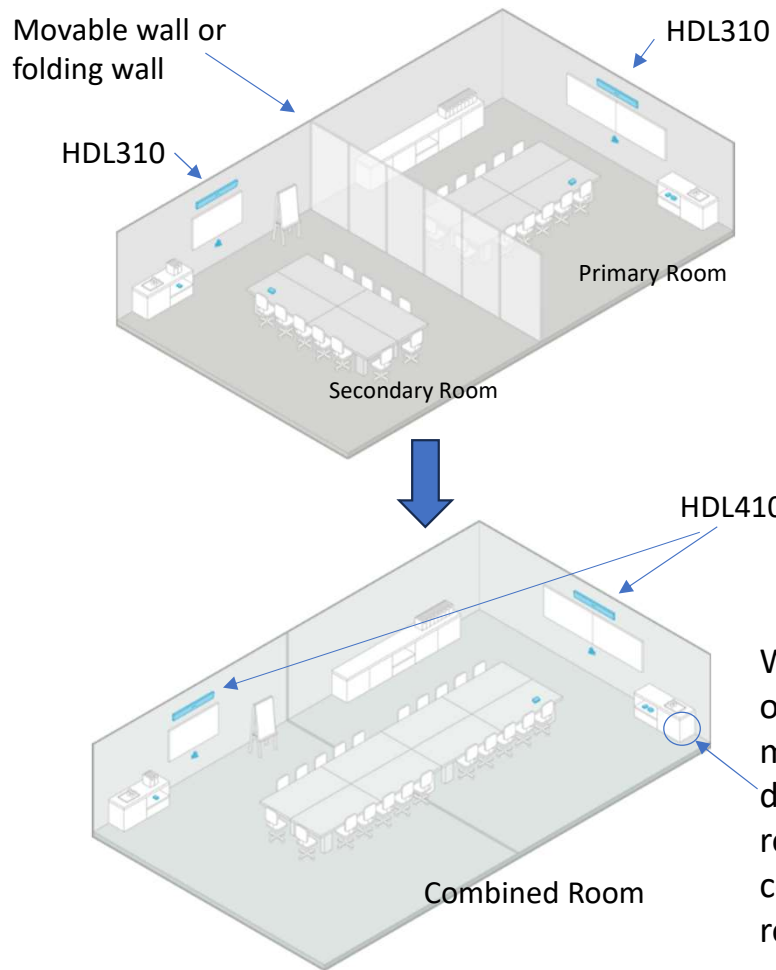

# III. Divisible Rooms

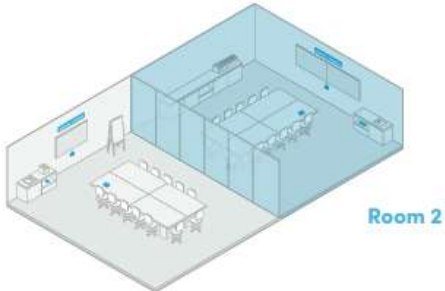
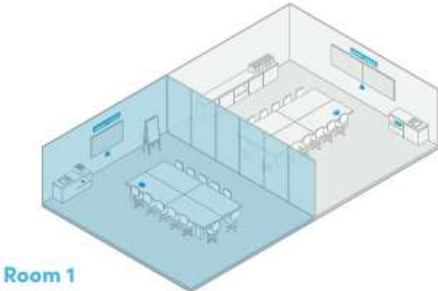
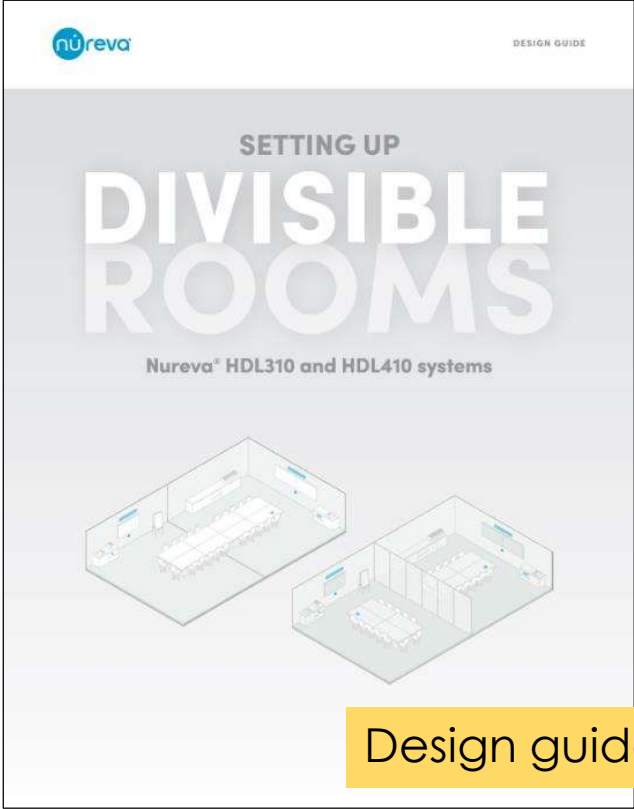

## IV. Full room Audio Pick up and Full Room Video

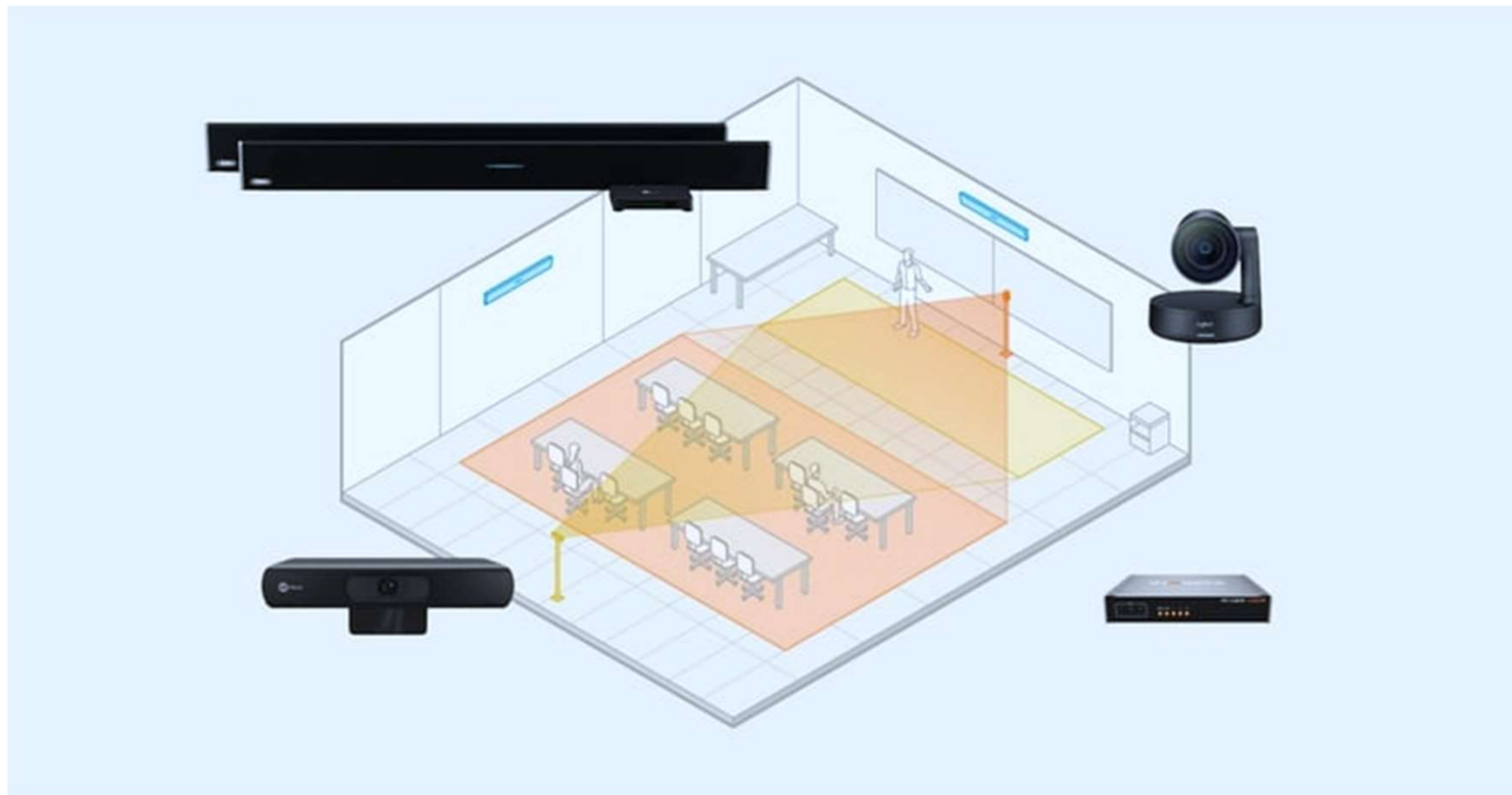

# IV. Full room Audio Pick up and Full Room Video

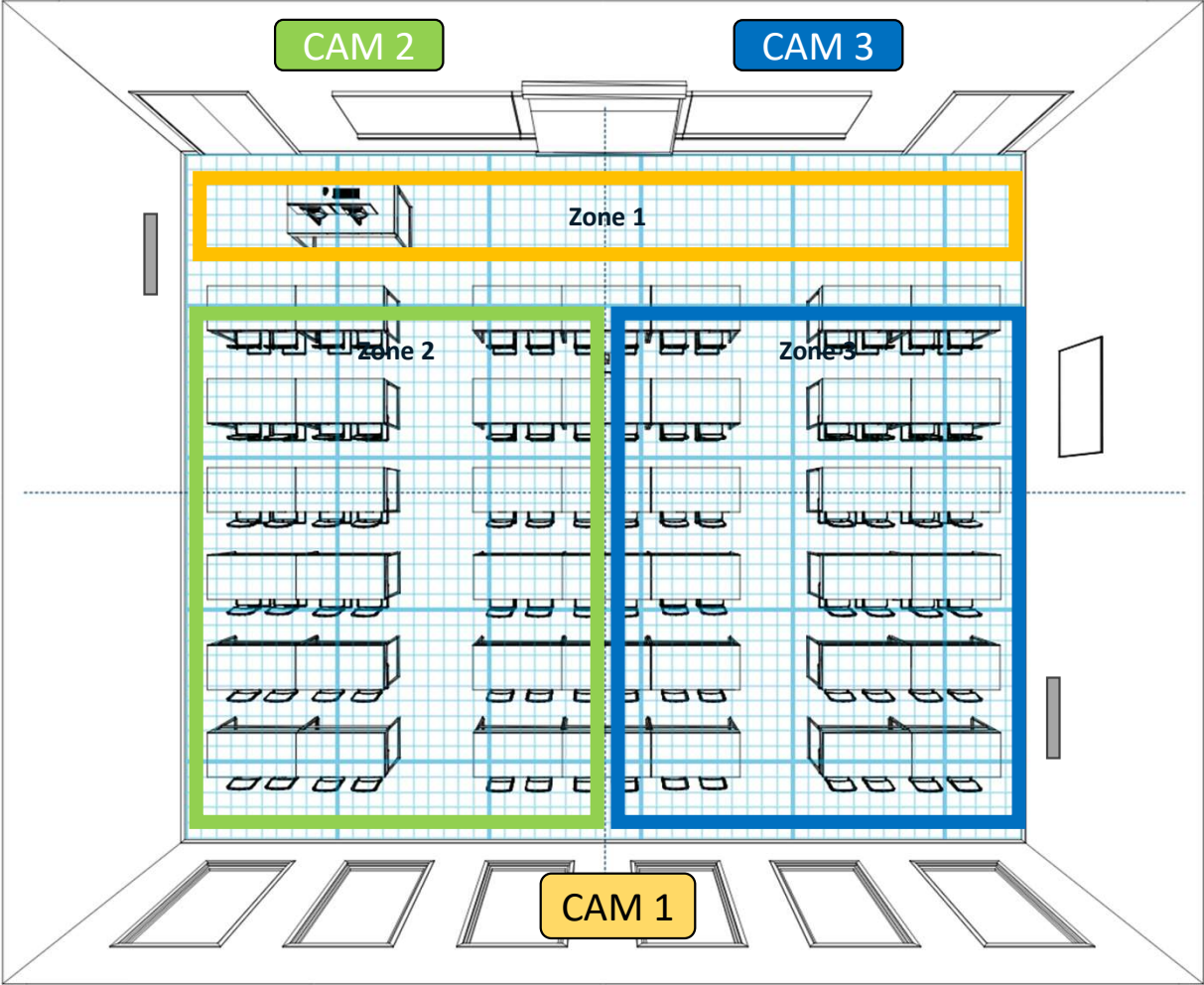

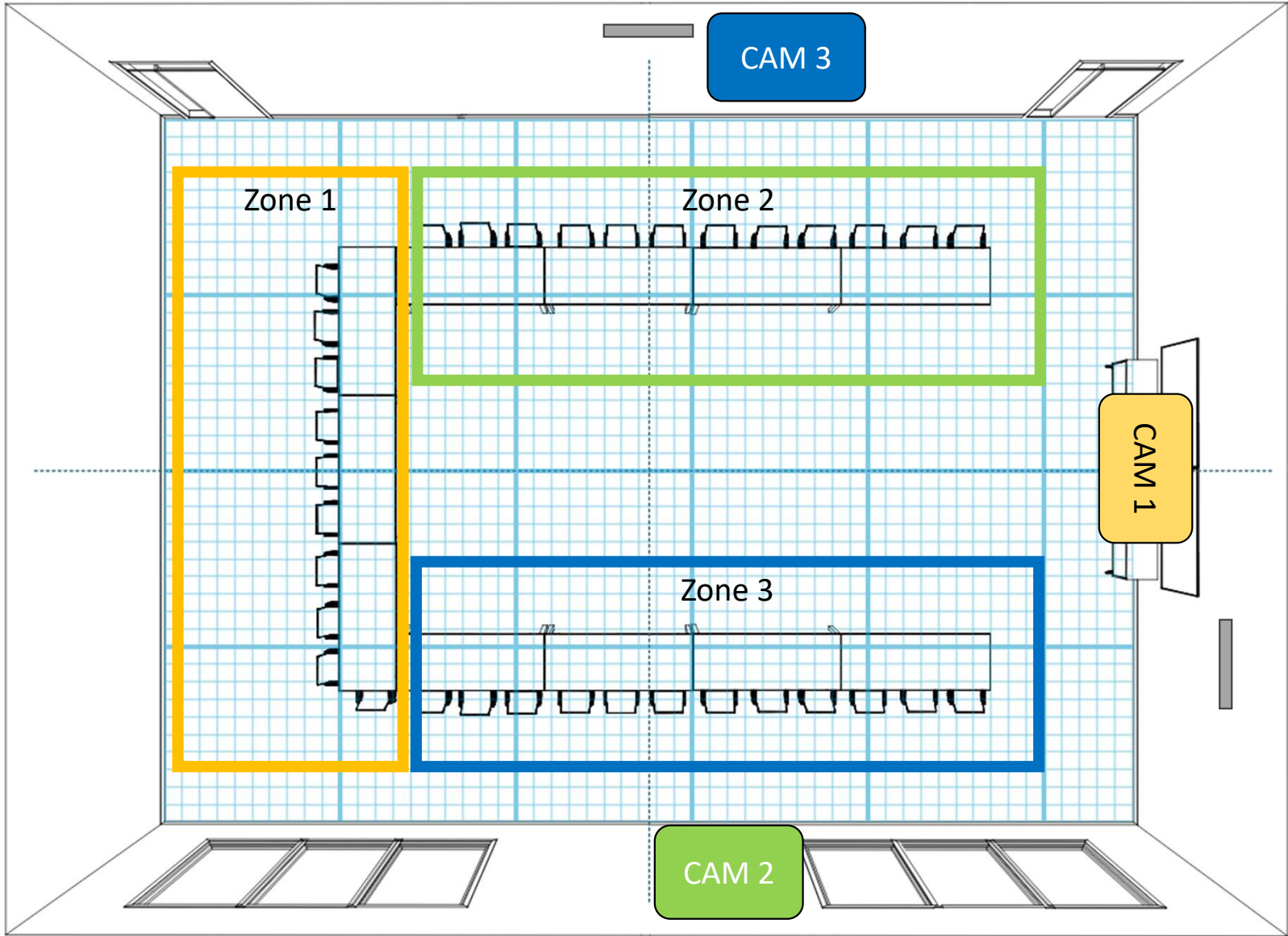



# Simplicity



# Challenges for Audio Conferencing

- I. Ease of installation
- II. Ease of integration
- III. Ease of management
- IV. Ease of upgrade

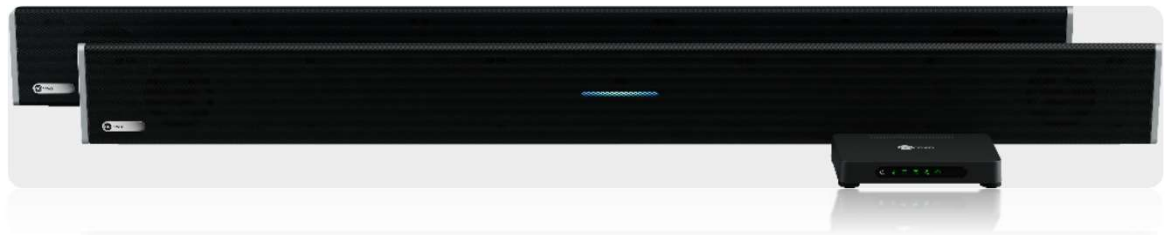



# Questions